



MDT

POPPET TYPE SOLENOID OPERATED DIRECTIONAL CONTROL VALVE SERIES 10

MODULAR VERSION

CETOP 03

p max 250 bar

Q max 25 l/min

MOUNTING INTERFACE

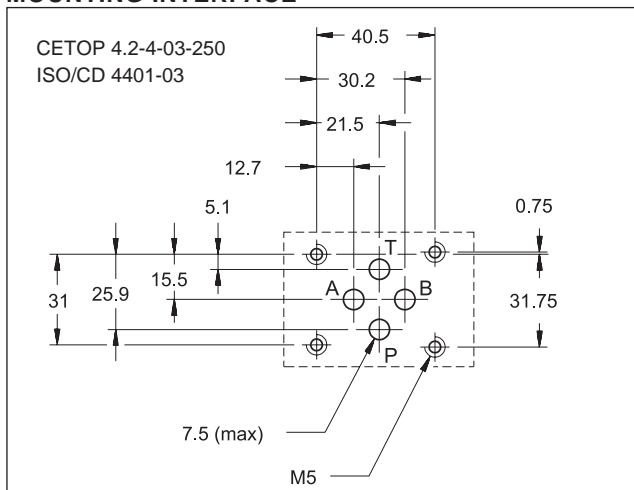

MODULAR VERSION

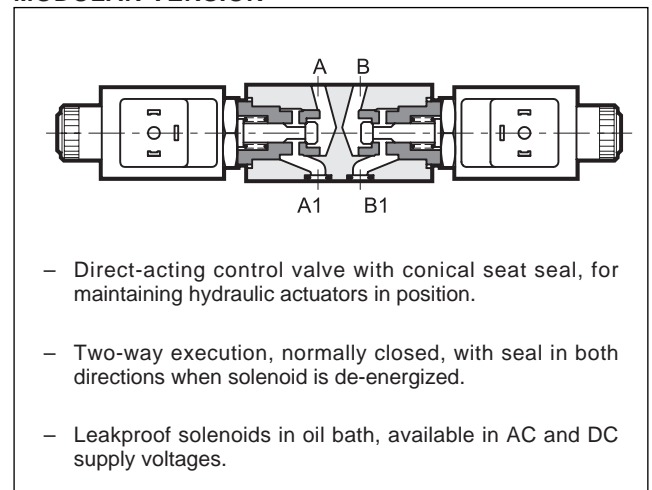

VALVE CONFIGURATIONS (see Hydraulic symbols table)

Configuration "SA": utilized when line A flow is to be controlled.

Configuration "SB": utilized when line B flow is to be controlled.

Configuration "D": utilized when flows of lines A and B are to be controlled

PERFORMANCE RATINGS (working with mineral oil of viscosity of 36 cSt at 50°C)

Maximum operation pressure	bar	250
Maximum flow rate in controlled lines	l/min	25
Maximum flow rate in free lines	l/min	65
Ambient temperature range	°C	-20 ÷ +50
Fluid temperature range	°C	-20 ÷ +70
Fluid viscosity range	cSt	2,8 ÷ 380
Recommended filtration	µm absolute	≤ 25
Recommended viscosity	cSt	25
Mass:		
MDT-D	kg	1,7
MDT-SA / SB	kg	1,2

HYDRAULIC SYMBOLS

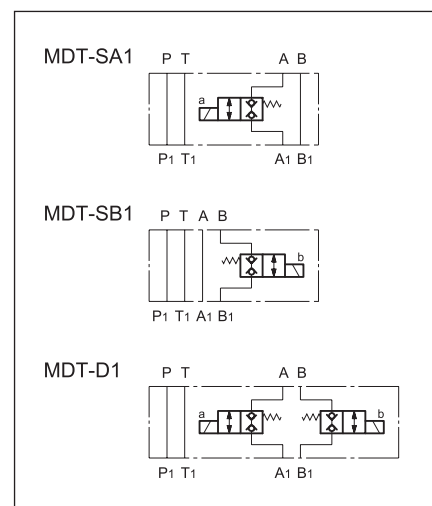



1 - IDENTIFICATION CODE

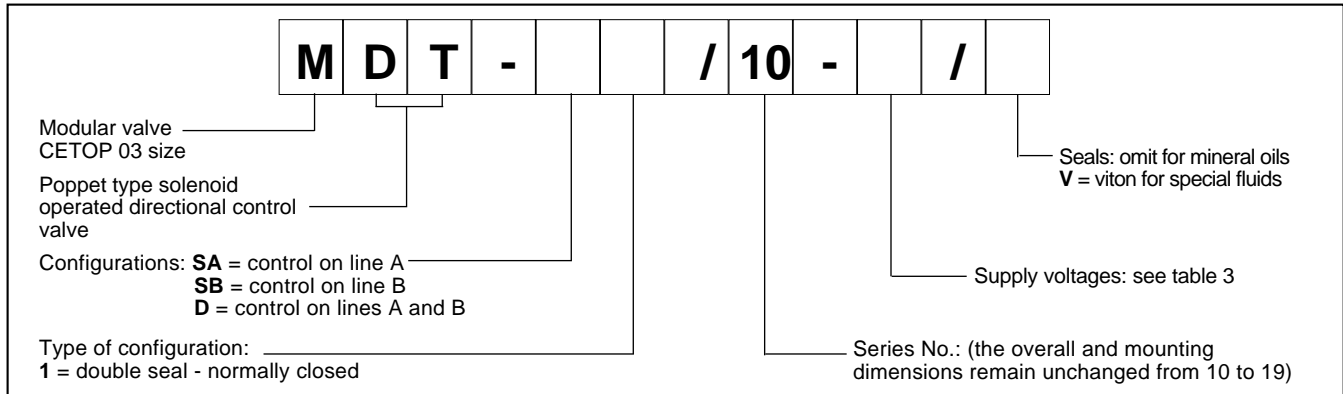

NOTE: The solenoid valves are never supplied with connector. Connectors must be ordered separately. For the identification of the connector type to be ordered, please see catalogue 49 000.

2 - CHARACTERISTIC CURVES (values obtained with viscosity 36 cSt at 50°C)

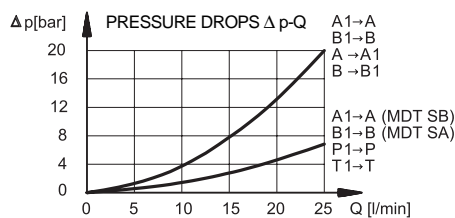
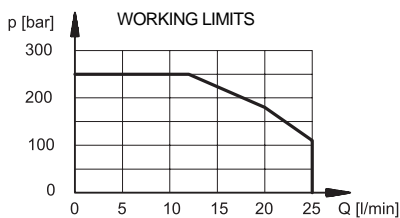

3 - SUPPLY VOLTAGES

DIRECT CURRENT	
12V DC	24V DC
ALTERNATING CURRENT	
110V RAC	220V RAC

Note: A connector with bridge rectifier and RAC coils are always used for alternating current supply.

Times	±10%
Energizing	30 ms
De-energizing	50 ms

4 - HYDRAULIC FLUIDS

Use mineral oil-based hydraulic fluids, with the addition of suitable anti-frothing and anti-oxidising agents. For the use of other fluid types (water glycol, phosphate esters and others), please consult our technical department.

5 - OVERALL AND MOUNTING DIMENSIONS

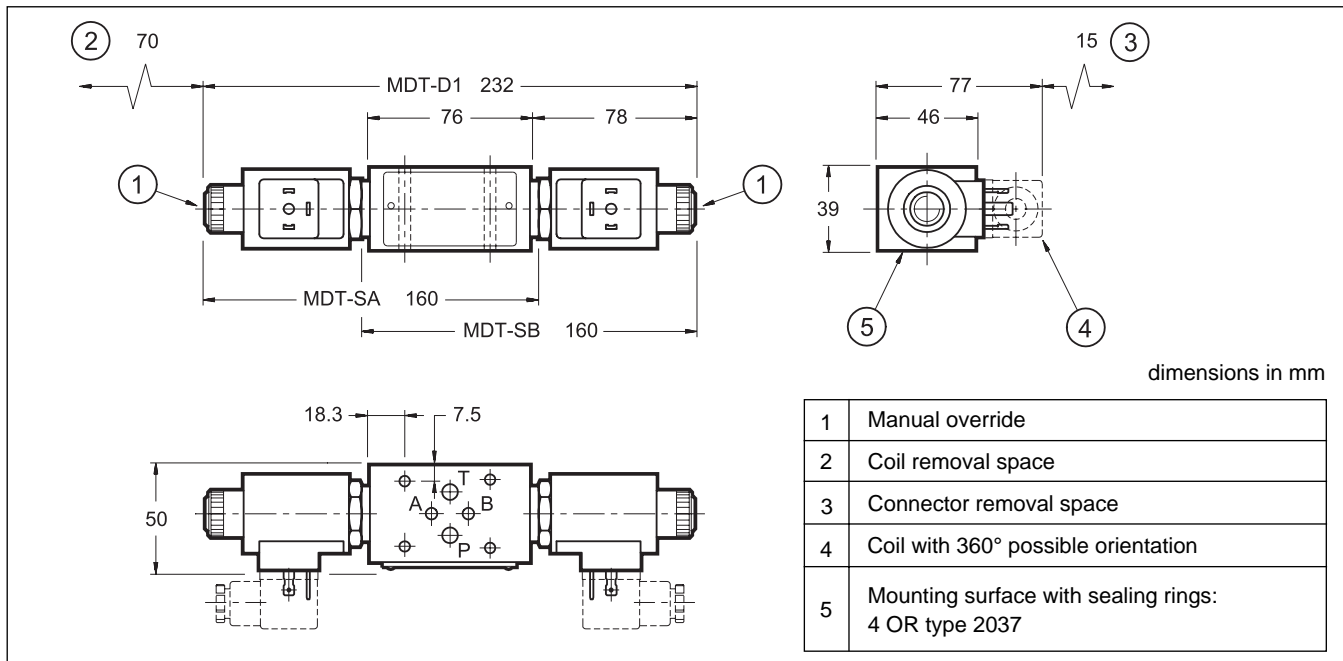

DIPLOMATIC OLEODINAMICA SpA
 20025 LEGNANO (MI) - P.le Bozzi, 1 / Via Edison
 Tel. 0331/472111-472236 - Fax 0331/548328